

LOAD CENTERS TYPE LD/LDE/LDS



CE

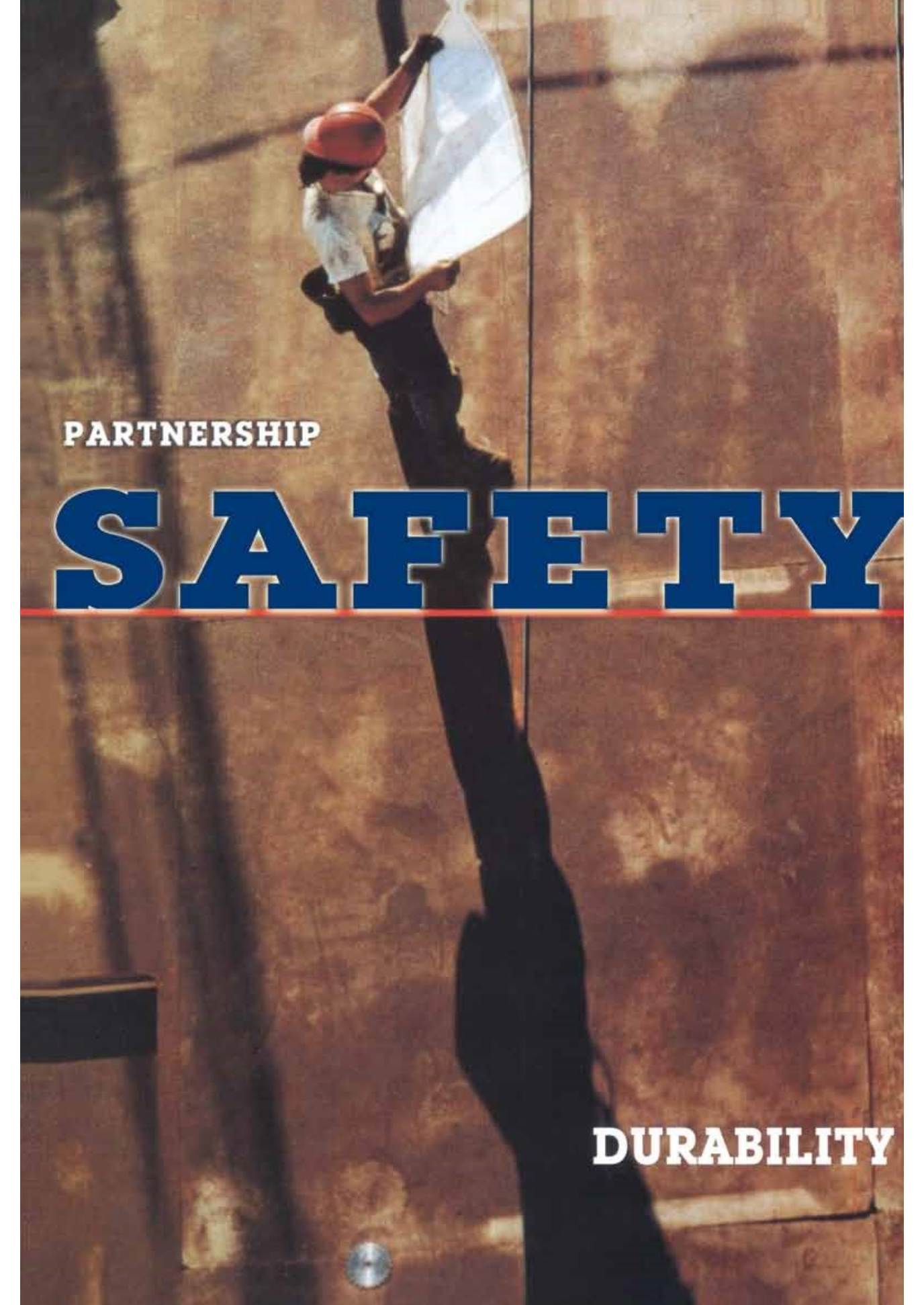

ISO 9001:2008
Certificate No: 34039

A construction worker wearing a red hard hat and a safety vest is looking at a set of blueprints on a large, rusty metal wall. The worker is positioned in the upper left quadrant of the frame. The wall is made of large, rectangular panels with visible rivets and a weathered, brownish-orange patina. A long, dark shadow of the worker is cast across the wall, extending from the bottom right towards the center. The overall scene is brightly lit, suggesting an outdoor or well-lit indoor environment.

PARTNERSHIP

SAFETY

DURABILITY

● APPLICATION

alfanar Load Centres have been designed for safe and reliable distribution and control of electrical power as service entrance in residential, commercial and light industrial premises. The Load Centre type LD is a complementary family of load centres with DIN rail type (IEC Standard) branch with main incomer as isolator or breaker. It is also available with main as ELCB.

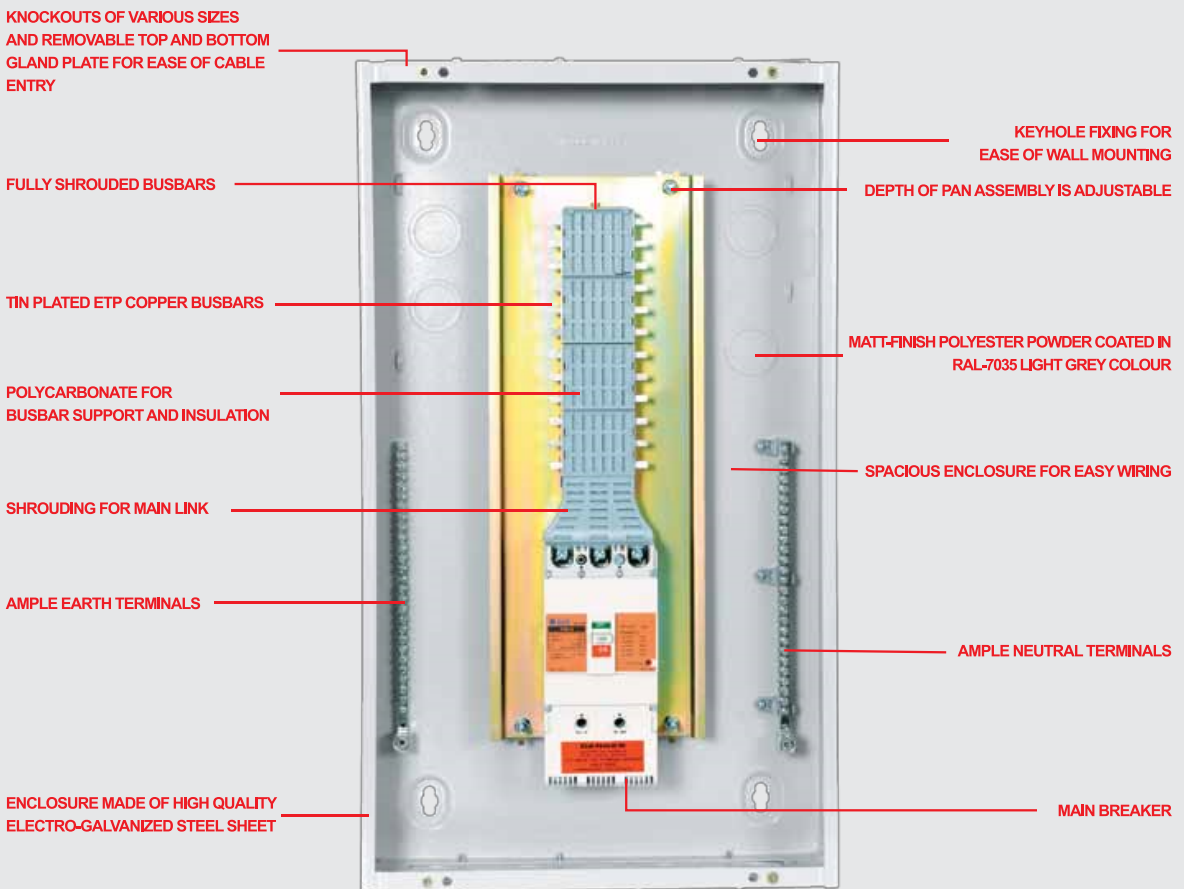

Figure 1

● FEATURES

- Made of high quality electro-galvanized steel sheet
- Tin plated ETP copper busbar
- Polyester powder coating RAL-7035
- Available cable tie & cable holding for easy wiring installations

● SPECIFICATIONS

ITEM	DESCRIPTION
Standard	IEC 60439 – 3 / IEC 60529
Busbar Rating	100 to 225A MAX
Busbar Type	ETP copper flat fully shrouded
Voltage Rating	120-440V AC 50/60 Hz
No. of Ways	3PH : 12,18, 24, 30, 36, 42, 48 2PH : 4, 6, 8, 10, 12, 14, 16 1PH : 4, 6, 8, 10,12, 14, 16
Degree Of Protection	IP40 (NEMA 1) & IP54 (NEMA 3R)
Enclosure Material	Electro-galvanized steel sheet (corrosion resistant)
Steel Thickness	Up to 1.2 mm
Knockout Sizes	See details on page 10, Figure 25
Enclosure Colour	Polyester powder coated in RAL-7035 Grey colour
Paint Thickness	70-90 microns
Main Breaker (Incomer)	MCB, MCCB, ELCB, ISOLATOR
Terminal Capacity	MCB Frame Size 100 A : 50 sq.mm MCCB Frame Size 100A : 95 sq.mm MCCB Frame Size 225A : 185 sq.mm ELCB Frame Size 100A : 35 sq.mm
Branches	1, 2 & 3 Pole Dinrail MCBs
Neutral Terminal Bar	Incoming Cable Lug : 50,150 sq.mm Outgoing Terminals : 16 sq.mm No. of Outgoing Terminals : Equivalent or more than No. of ways
Earth Terminal Bar	Incoming Cable Lug : 50,150 sq.mm Outgoing Terminals : 16 sq.mm No. of Outgoing Terminals : Equivalent or more than No. of ways
Rated Insulation Voltage	690 V AC
Ambient Temperature	50 °C



Figure 2



Figure 3



Figure 4

1- INDOOR TYPE

Standard Load Center (Type LD)
IEC Compliant Distribution Board
IEC Standards (IEC 60439-3 And IEC 60529)

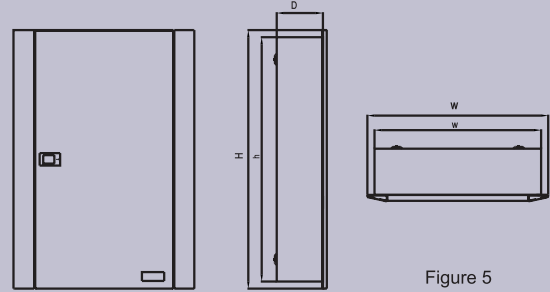

Figure 5

LD Single-Phase LC 63 A With Isolator Main

NO. OF WAYS	ORDERING NUMBER AND TYPE												
	1 POLE	FLUSH	H	h	W	w	D	SURFACE	H	h	W	w	D
4	43-I104063		273	243	280	250	95	43-I104063S	248	243	255	250	95
6	43-I106063		309	279	280	250	95	43-I106063S	284	279	255	250	95
8	43-I108063		345	315	280	250	95	43-I108063S	320	315	255	250	95
10	43-I110063		381	351	280	250	95	43-I110063S	356	351	255	250	95
12	43-I112063		417	387	280	250	95	43-I112063S	392	387	255	250	95
14	43-I114063		453	423	280	250	95	43-I114063S	428	423	255	250	95
16	43-I116063		489	459	280	250	95	43-I116063S	464	459	255	250	95



Figure 6

Main Breaker: 63A

Change last four digits for required ratings and mounting

For example:

43-I112063 Represents load center 12 way with 63A main flush type

43-I112063S Represents load center 12 way with 63A main surface type

LD Single-Phase LC 100 A With Isolator Main

NO. OF WAYS	ORDERING NUMBER AND TYPE												
	1 POLE	FLUSH	H	h	W	w	D	SURFACE	H	h	W	w	D
4	43-I104100		273	243	280	250	95	43-I104100S	248	243	255	250	95
6	43-I106100		309	279	280	250	95	43-I106100S	284	279	255	250	95
8	43-I108100		345	315	280	250	95	43-I108100S	320	315	255	250	95
10	43-I110100		381	351	280	250	95	43-I110100S	356	351	255	250	95
12	43-I112100		417	387	280	250	95	43-I112100S	392	387	255	250	95
14	43-I114100		453	423	280	250	95	43-I114100S	428	423	255	250	95
16	43-I116100		489	459	280	250	95	43-I116100S	464	459	255	250	95



Figure 7

Main Breaker: 100A

Change last four digits for required ratings and mounting

For example:

43-I112100 Represents load center 12 way with 100A main flush type

43-I112100S Represents load center 12 way with 100A main surface type

INDOOR TYPE

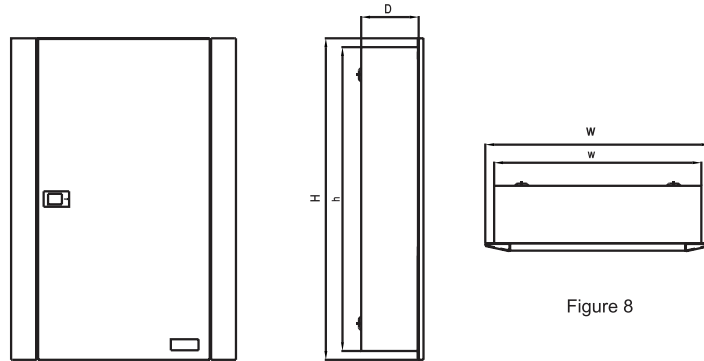

Figure 8

LD Two-Phase LC 63 A With Isolator Main

NO. OF WAYS	ORDERING NUMBER AND TYPE											
	1 POLE	FLUSH	H	h	W	w	D	SURFACE	H	h	W	w
4	43-0404063	273	243	280	250	95	43-0404063S	248	243	255	250	95
6	43-0406063	309	279	280	250	95	43-0406063S	284	279	255	250	95
8	43-0408063	345	315	280	250	95	43-0408063S	320	315	255	250	95
10	43-0410063	381	351	280	250	95	43-0410063S	356	351	255	250	95
12	43-0412063	417	387	280	250	95	43-0412063S	392	387	255	250	95
14	43-0414063	453	423	280	250	95	43-0414063S	428	423	255	250	95
16	43-0416063	489	459	280	250	95	43-0416063S	464	459	255	250	95



Figure 9

Main Breaker: 63A

Change last four digits for required ratings and mounting

For example:

43-0412063 Represents load center 12 way with 63A main flush type

43-0412063S Represents load center 12 way with 63A main surface type

LD Two-Phase LC 100 A With Isolator Main

NO. OF WAYS	ORDERING NUMBER AND TYPE											
	1 POLE	FLUSH	H	h	W	w	D	SURFACE	H	h	W	w
4	43-04100	273	243	280	250	95	43-0404100S	248	243	255	250	95
6	43-06100	309	279	280	250	95	43-0406100S	284	279	255	250	95
8	43-08100	345	315	280	250	95	43-0408100S	320	315	255	250	95
10	43-0410100	381	351	280	250	95	43-0410100S	356	351	255	250	95
12	43-0412100	417	387	280	250	95	43-0412100S	392	387	255	250	95
14	43-0414100	453	423	280	250	95	43-0414100S	428	423	255	250	95
16	43-0416100	489	459	280	250	95	43-0416100S	464	459	255	250	95



Figure 10

Main Breaker: 100A

Change last four digits for required ratings and mounting

For example:

43-0412100 Represents load center 12 way with 100A main flush type

43-0412100S Represents load center 12 way with 100A main surface type

LD Three-Phase LC 100 A With Isolator Main

NO. OF WAYS		ORDERING NUMBER AND TYPE											
1 POLE	3 POLE	FLUSH	H	h	W	w	D	SURFACE	H	h	W	w	D
12	4	43-12100	582	550	407	375	105	43-12100S	582	550	407	375	105
18	6	43-18100	637	605	407	375	105	43-18100S	637	605	407	375	105
24	8	43-24100	692	660	407	375	105	43-24100S	692	660	407	375	105
30	10	43-30100	747	715	407	375	105	43-30100S	747	715	407	375	105
36	12	43-36100	802	770	407	375	105	43-36100S	802	770	407	375	105
42	14	43-42100	857	825	407	375	105	43-42100S	857	825	407	375	105

Main Breaker: 100A

Change last four digits for required ratings and mounting

For example:

43-30100 Represents load center 30 way with 100A main flush type

43-30100S Represents load center 30 way with 100A main surface type



Figure 11

LD Three-Phase LC With MCCB Main Rating From 30-100 AF

NO. OF WAYS		ORDERING NUMBER AND TYPE											
1 POLE	3 POLE	FLUSH	H	h	W	w	D	SURFACE	H	h	W	w	D
12	4	43-L12100	582	550	407	375	105	43-L12100S	582	550	407	375	105
18	6	43-L18100	637	605	407	375	105	43-L18100S	637	605	407	375	105
24	8	43-L24100	692	660	407	375	105	43-L24100S	692	660	407	375	105
30	10	43-L30100	747	715	407	375	105	43-L30100S	747	715	407	375	105
36	12	43-L36100	802	770	407	375	105	43-L36100S	802	770	407	375	105
42	14	43-L42100	857	825	407	375	105	43-L42100S	857	825	407	375	105

Main Breaker: Ranges from 30-100A

Change last four digits for required ratings and mounting

For example:

43-L12060 Represents load center 12 way with 60A main flush type

43-L12100S Represents load center 12 way with 100A main surface type



Figure 12

LD Three-Phase LC With MCCB Main Rating From 125-225 AF

NO. OF WAYS		ORDERING NUMBER AND TYPE											
1 POLE	3 POLE	FLUSH	H	h	W	w	D	SURFACE	H	h	W	w	D
12	4	43-12225	692	660	407	375	105	43-12225S	692	660	407	375	105
18	6	43-18225	747	715	407	375	105	43-18225S	747	715	407	375	105
24	8	43-24225	802	770	407	375	105	43-24225S	802	770	407	375	105
30	10	43-30225	857	825	407	375	105	43-30225S	857	825	407	375	105
36	12	43-36225	912	880	407	375	105	43-36225S	912	880	407	375	105
42	14	43-42225	967	935	407	375	105	43-42225S	967	935	407	375	105
48	16	43-48225	1022	990	407	375	105	43-48225S	1022	990	407	375	105

Main Breaker: Ranges from 125-225A

Change last four digits for required ratings and mounting

For example:

43-42125 Represents load center 42 way with 125A main flush type

43-42225S Represents load center 42 way with 225A main surface type



Figure 13

INDOOR TYPE

LDE One-Phase LC With 2 Pole ELCB Main

NO. OF WAYS	ORDERING NUMBER AND TYPE												
	1 POLE	FLUSH	H	h	W	w	D	SURFACE	H	h	W	D	w
4	43-E104063030	273	243	280	250	95	43-E104063030S	248	243	255	250	95	
6	43-E106063030	309	279	280	250	95	43-E106063030S	284	279	255	250	95	
8	43-E108063030	345	315	280	250	95	43-E108063030S	320	315	255	250	95	
10	43-E110063030	381	351	280	250	95	43-E110063030S	356	351	255	250	95	
12	43-E112063030	417	387	280	250	95	43-E112063030S	392	387	255	250	95	
14	43-E114063030	453	423	280	250	95	43-E114063030S	428	423	255	250	95	
16	43-E116063030	489	459	280	250	95	43-E116063030S	464	459	255	250	95	



Figure 14

Please Select Your Product As Mentioned Below

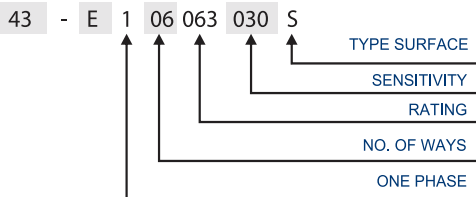

AVAILABLE RANGE:
 1- 2P, 63A, 30 mA
 2- 2P, 63A, 100 mA
 3- 2P, 63A, 300 mA*
 4- 2P, 63A, 500 mA*

*Will be manufactured on special request

LDE Three-Phase LC With 4 Pole ELCB Main

NO. OF WAYS	ORDERING NUMBER AND TYPE													
	1 POLE	3 POLE	FLUSH	H	h	W	w	D	SURFACE	H	h	W	w	D
12	4	43-E312063030	525	495	373	343	105	43-E312063030S	508	495	356	343	105	
18	6	43-E318063030	579	549	373	343	105	43-E318063030S	562	549	356	343	105	
24	8	43-E324063030	633	603	373	343	105	43-E324063030S	616	603	356	343	105	
30	10	43-E330063030	687	657	373	343	105	43-E330063030S	670	657	356	343	105	
36	12	43-E336063030	741	711	373	343	105	43-E336063030S	724	711	356	343	105	
42	14	43-E342063030	795	765	373	343	105	43-E342063030S	778	765	356	343	105	



Figure 15

Please Select Your Product As Mentioned Below

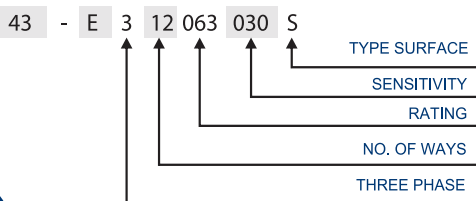

AVAILABLE RANGE:
 1- 4P, 63A, 30 mA
 2- 4P, 63A, 100 mA
 3- 4P, 63A, 300 mA*
 4- 4P, 63A, 500 mA*
 5- 4P, 100A, 30 mA
 6- 4P, 100A, 100 mA
 7- 4P, 100A, 300 mA*
 8- 4P, 100A, 500 mA*

*Will be manufactured on special request

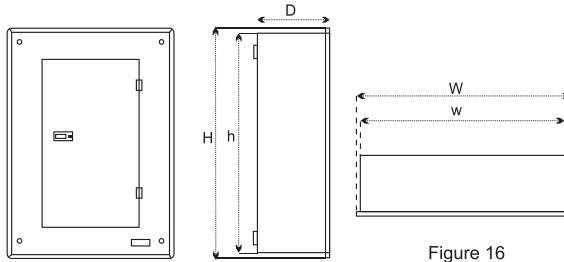

Figure 16

LDS

Three-Phase 2 Section Load Center With 3 Pole Main Isolator or MCB And One Section Protected By 4 Pole ELCB

NO. OF WAYS		ORDERING NUMBER AND TYPE											
1 POLE	3 POLE	FLUSH	H	h	W	w	D	SURFACE	H	h	W	w	D
6+6	2+2	48-I060610020	712	682	373	343	105	48-I060610020S	696	682	357	343	105
12+6	4+2	48-I120610020	766	736	373	343	105	48-I120610020S	750	736	357	343	105
12+12	4+4	48-I121210020	820	790	373	343	105	48-I121210020S	804	790	357	343	105
18+12	6+4	48-I181210020	874	844	373	343	105	48-I181210020S	858	844	357	343	105
18+18	6+6	48-I181810020	920	890	373	343	105	48-I181810020S	904	890	357	343	105
24+18	8+6	48-I241810020	974	944	373	343	105	48-I241810020S	958	944	357	343	105

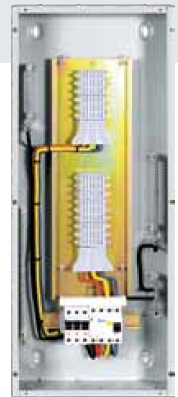

Figure 17

LDS

Three-Phase 2 Section Load Center With 3 Pole Main MCCB And One Section Protected By 4 Pole ELCB

NO. OF WAYS		ORDERING NUMBER AND TYPE											
1 POLE	3 POLE	FLUSH	H	h	W	w	D	SURFACE	H	h	W	w	D
6+6	2+2	48-L060610020	906	876	430	400	105	48-L060610020S	890	876	414	400	105
12+6	4+2	48-L120610020	960	930	430	400	105	48-L120610020S	944	930	414	400	105
12+12	4+4	48-L121210020	1014	984	430	400	105	48-L121210020S	998	984	414	400	105
18+12	6+4	48-L181210020	1068	1038	430	400	105	48-L181210020S	1052	1038	414	400	105
18+18	6+6	48-L181810020	1122	1092	430	400	105	48-L181810020S	1106	1092	414	400	105
24+18	8+6	48-L241810020	1176	1146	430	400	105	48-L241810020S	1160	1146	414	400	105

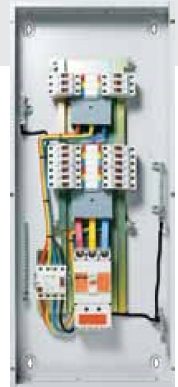
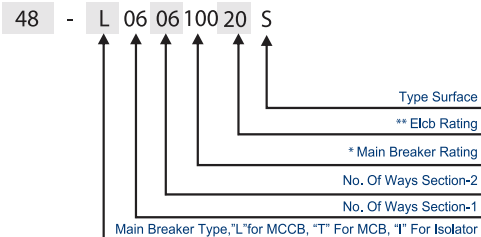

Figure 18

Please Select Your Product As Mentioned Below



* MAIN BREAKER RATING		** ELCB RATING	
CODE #	RATING	CODE #	RATING
063-100	63, 100A ISOLATOR "I"	20	63A 30mA
030-100	FOR 30, 40, 50, 60, 70, 100A MCB "T"	30	100A 30mA
030-100	FOR 30, 40, 50, 60, 75, 100A MCCB "L"	40	63A 100mA
125-225	FOR 125, 150, 175, 200, 225A MCCB "L"	50	100A 100mA

LDS

Three-Phase 2 Section Load Center With 3 Pole Main Isolator or MCB And Both Sections Protected By 2 Nos. of 4 Pole ELCBs

NO. OF WAYS		ORDERING NUMBER AND TYPE											
1 POLE	3 POLE	FLUSH	H	h	W	w	D	SURFACE	H	h	W	w	D
6+6	2+2	48-I06061002020	712	682	373	343	105	48-I06061002020S	696	682	357	343	105
12+6	4+2	48-I12061002020	766	736	373	343	105	48-I12061002020S	750	736	357	343	105
12+12	4+4	48-I12121002020	820	790	373	343	105	48-I12121002020S	804	790	357	343	105
18+12	6+4	48-I18121002020	874	844	373	343	105	48-I18121002020S	858	844	357	343	105
18+18	6+6	48-I18181002020	920	890	373	343	105	48-I18181002020S	904	890	357	343	105
24+18	8+6	48-I24181002020	974	944	373	343	105	48-I24181002020S	958	944	357	343	105

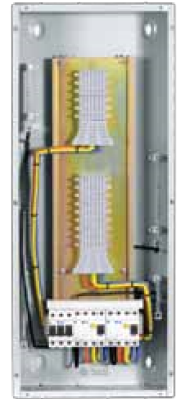

Figure 19

LDS

Three-Phase 2 Section Load Center With 3 Pole Main MCCB And Both Sections Protected By 2 Nos. of 4 Pole ELCBs

NO. OF WAYS		ORDERING NUMBER AND TYPE											
1 POLE	3 POLE	FLUSH	H	h	W	w	D	SURFACE	H	h	W	w	D
6+6	2+2	48-L06061002020	906	876	430	400	105	48-L06061002020S	890	876	414	400	105
12+6	4+2	48-L12061002020	960	930	430	400	105	48-L12061002020S	944	930	414	400	105
12+12	4+4	48-L12121002020	1014	984	430	400	105	48-L12121002020S	998	984	414	400	105
18+12	6+4	48-L18121002020	1068	1038	430	400	105	48-L18121002020S	1052	1038	414	400	105
18+18	6+6	48-L18181002020	1122	1092	430	400	105	48-L18181002020S	1106	1092	414	400	105
24+18	8+6	48-L24181002020	1176	1146	430	400	105	48-L24181002020S	1160	1146	414	400	105

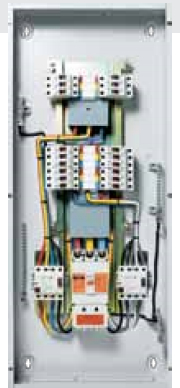
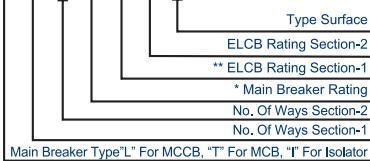

Figure 20

48 - L 06 06 100 20 20 S



* MAIN BREAKER RATING		** ELCB RATING	
CODE #	RATING	CODE #	RATING
063-100	63, 100A ISOLATOR "I"	20	63A 30mA
030-100	FOR 30, 40,50,60,70,100A MCB "T"	30	100A 30mA
030-100	FOR 30, 40,50,60,75,100A MCCB "L"	40	63A 100mA
125-225	FOR 125,150,175,200,225A MCCB "L"	50	100A 100mA

Please Select Your Product As Mentioned Above

2- OUTDOOR TYPE

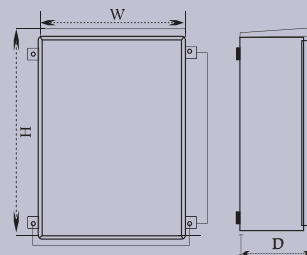

Figure 21

LD Three-Phase LC 100A With Isolator Main

NO. OF WAYS		ORDERING NUMBER AND TYPE			
1 POLE	3 POLE	CODE	H	W	D
12	4	43-WP12100	515	350	160
18	6	43-WP18100	592	350	160
24	8	43-WP24100	668	350	160
30	10	43-WP30100	745	350	160
36	12	43-WP36100	821	350	160
42	14	43-WP42100	898	350	160

Main Breaker: 100A

Change last three digits for required ratings

For example:

43-WP42100 Represents load center 42 way with 100A main

43-WP24100 Represents load center 24 way with 100A main



Figure 22

LD Three-Phase LC 100A With MCCB Main Rating From 30-100AF

NO. OF WAYS		ORDERING NUMBER AND TYPE			
1 POLE	3 POLE	CODE	H	W	D
12	4	43-WPL12100	515	350	160
18	6	43-WPL18100	592	350	160
24	8	43-WPL24100	668	350	160
30	10	43-WPL30100	745	350	160
36	12	43-WPL36100	821	350	160
42	14	43-WPL42100	898	350	160

Main Breaker: Ranges from 30-100A

Change last three digits for required ratings

For example:

43-WP18030 Represents load center 18 way with 30A main

43-WP18100 Represents load center 18 way with 100A main



Figure 23

LD Three-Phase LC With MCCB Main Rating From 125-225AF

NO. OF WAYS		ORDERING NUMBER AND TYPE			
1 POLE	3 POLE	CODE	H	W	D
12	4	43-WPL12225	615	350	160
18	6	43-WPL18225	692	350	160
24	8	43-WPL24225	768	350	160
30	10	43-WPL30225	845	350	160
36	12	43-WPL36225	921	350	160
42	14	43-WPL42225	998	350	160
48	16	43-WPL48225	1074	350	160

Main Breaker: Ranges from 125-225A

Change last three digits for required ratings

For example:

43-WPL42125 Represents load center 42 way with 125A main

43-WPL42225 Represents load center 42 way with 225A main



Figure 24

● LD KNOCKOUTS

LD 3PH 100A MAIN 12W-42W

- A- $\varnothing 19/\varnothing 25$ DOUBLE KNOCKOUT - 18 Nos.
- B- $\varnothing 35/\varnothing 43.5$ DOUBLE KNOCKOUT - 6 Nos.
- C- $\varnothing 23/\varnothing 28/\varnothing 33$ TRIPLE KNOCKOUT - 4 Nos.
- D- $\varnothing 44/\varnothing 50/\varnothing 62$ TRIPLE KNOCKOUT - 6 Nos.
- E- WALL MOUNTING EMBOSS WITH KEY HOLE- 4Nos.

Notes:

- All dimension are in mm
- The details in this drawing indicate dimensions and knockout positions for one **alfanar** Load Center. Knockout details for other Load Center types, shown in this catalogue, are available on request

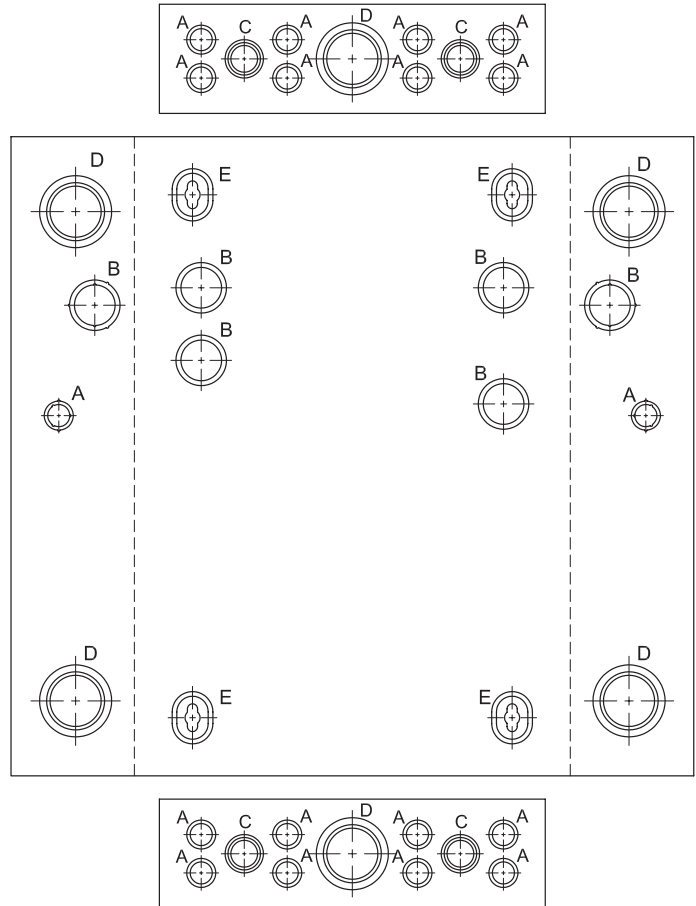

Figure 25

● TESTING

All **alfanar** load centers type (LD) are type tested for complete sequence as per international standards.

Each of our products undergo strict quality control check and is routinely checked for:

- Dielectric Test** : A high voltage routine test
- Electrical Continuity Test** : To confirm correct assembly & operation
- Insulation Resistance Test** : To ensure high insulation resistance

Moulded Case Circuit Breaker (MCCB)

alfanar MOULDED CASE CIRCUIT BREAKER ELA

S/NO.	Description
1	alfanar MCCB 3P(ELA) 30A
2	alfanar MCCB 3P(ELA) 40A
3	alfanar MCCB 3P(ELA) 50A
4	alfanar MCCB 3P(ELA) 60A
5	alfanar MCCB 3P(ELA) 75A
6	alfanar MCCB 3P(ELA)100A



Figure 26

alfanar MOULDED CASE CIRCUIT BREAKER ELB

S/NO.	Description
1	alfanar MCCB 3P(ELB) 125A
2	alfanar MCCB 3P(ELB) 150A
3	alfanar MCCB 3P(ELB) 175A
4	alfanar MCCB 3P(ELB) 200A
5	alfanar MCCB 3P(ELB) 225A

Dimensions

ELA 30-100A

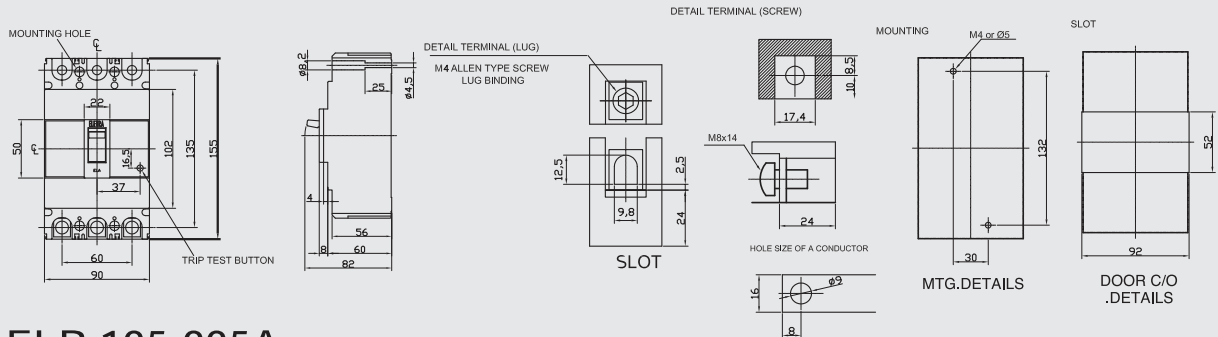

ELB 125-225A

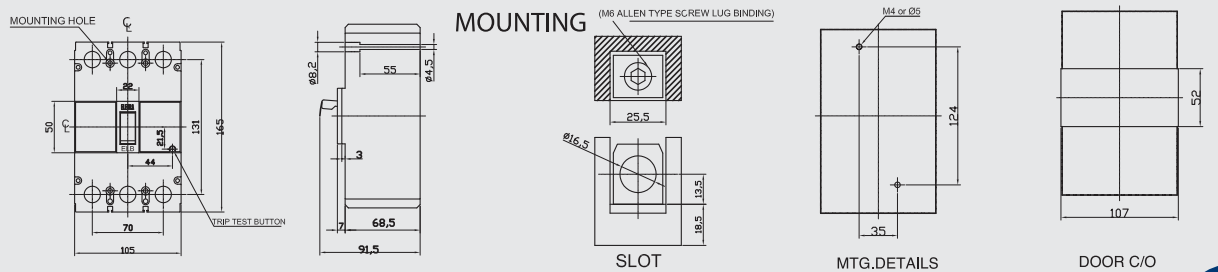

Figure 27

Moulded Case Circuit Breaker (MCCB)

TECHNICAL SPECIFICATION

alfanar MOULDED CASE CIRCUIT BREAKER			
Frame size (AF)		100	225
Frame Type		ELA	ELB
Breaking capacity (kA), Icu at 415V AC		14	14
Number of poles		3	3
Type	3 pole	ELA 100A	ELB 225A
Rated current (A) at 50 °C		30,40	125,150
		50,60,75,100	175,200,225
Technical data conforming to IEC/EN60947-2			
Rated operational voltage (V) Ue (50/60 Hz)		600	600
Rated operational voltage (V) Ue (DC)		250	250
Rated insulation voltage (V) Ui (50/60Hz)		690	690
Rated impulse withstand voltage (kv)uimp		6	6
Ultimate breaking capacity (kA)Icu			
AC 50/60 Hz	220/240V	25	25
	380/415V	14	14
	440/460V	14	14
	480/500V	7.5	7.5
	600V	7.5	7.5
DC	125V	15	15
	250V	10	10
Service breaking capacity(%Icu).Ics		50	50
Category of use		A	A
Endurance (number of operations)	mechanical	8500	7000
	electrical	1500	1000
Type of trip unit:			
-Thermal-magnetic release		fixed	fixed
-Electronic release		-	-
-Pre-alarm via LED		-	-
-Hydraulic-magnetic release		-	-
Accessories		-	-
Dimensions (WxHxD) mm		90x155x60	105x165x68,5
Weight (kg) - MAX		1.1	1.3



CERTIFICATION

alfanar products are approved by:

- SEC
Saudi Electric Company
- Saudi Aramco
- Saudi Arabian Oil Company
- SABIC
Saudi Basic Industries Corporation
- Royal Commission For Jubail and Yanbu
- SASO
Saudi Arabian Standards Organization
- Several Ministries, Universities and Governmental Organizations In Saudi Arabia
- Abu Dhabi Water and Electricity Board
- Ministry Of Electricity, Bahrain
- State Electricity Board, Qatar
- Public Electricity Corporation-
Ministry Of Electricity, Yemen

OUR OBJECTIVE

WE REACH EXACTING STANDARDS IN THE SAFETY AND DISTRIBUTION OF POWER AND GO WELL BEYOND A CUSTOMER'S EXPECTATIONS. THIS IS DONE BY FOCUSING OUR TECHNOLOGY AND EXPERTISE ON THE ULTIMATE REWARD WE CAN GET, COMPLETE SATISFACTION OF OUR CUSTOMERS.

QUALITY POLICY

The Quality Policy of alfanar is, to:

- Provide products conforming to governing standards and of consistent quality
- Excel in all our operations to achieve customers' satisfaction for products and services through continual improvement
- Develop and maintain a motivated team of competent employees and vendors
- Redefine and execute new processes/systems that meet market requirements.

alfanar PRODUCTS

- Switch and Socket Boxes
- Junction Boxes
- Metal Enclosures IP65
- Stainless Steel Enclosures NEMA-4x
- Telephone Enclosures
- Circuit Breaker Enclosures
- Busbar Chamber With Multiple Outlets
- Modular Enclosures
- Load Centers
 - NEMA Type LA Load Centers
 - IEC Type LD Load Centers
 - Split Busbar Units Type LAS/ LDS Load Centers
 - Raysan Load Centers
 - ALF Load Centers
- MCCB Distribution Boards
- Pump Control Panels
- Motor Control Centers
- LV Switchboards up to 6300A, Tested For 100KA - 1 sec Short Circuit Withstand
- Package Substations
- Control and Automation Panels
- Relay and Control Panels
- Medium Voltage Switchgears
- Pole Mounted Metering Structures
- AC/DC Panels up to 5000A , Tested For 85KA - 1 sec Short Circuit Withstand
- Extendable and Non-Extendable Ring Main Units



K.S.A. Toll Free: 800 124 1333
www.alfanar.com

As improvement of alfanar products is an ongoing process, technical specifications and other details shown in this catalogue may change from time to time